

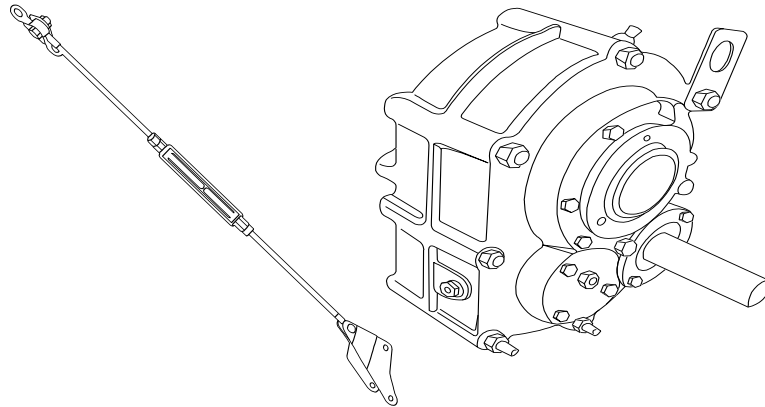

SHAFT MOUNT SPEED REDUCER MODEL # SMR10-25/1



SPECIFICATIONS - Exact Dimensional Drop-In For All Major Makes

Box Size	Ratio	Output Bore
10	25:1	5-7/16" Max.

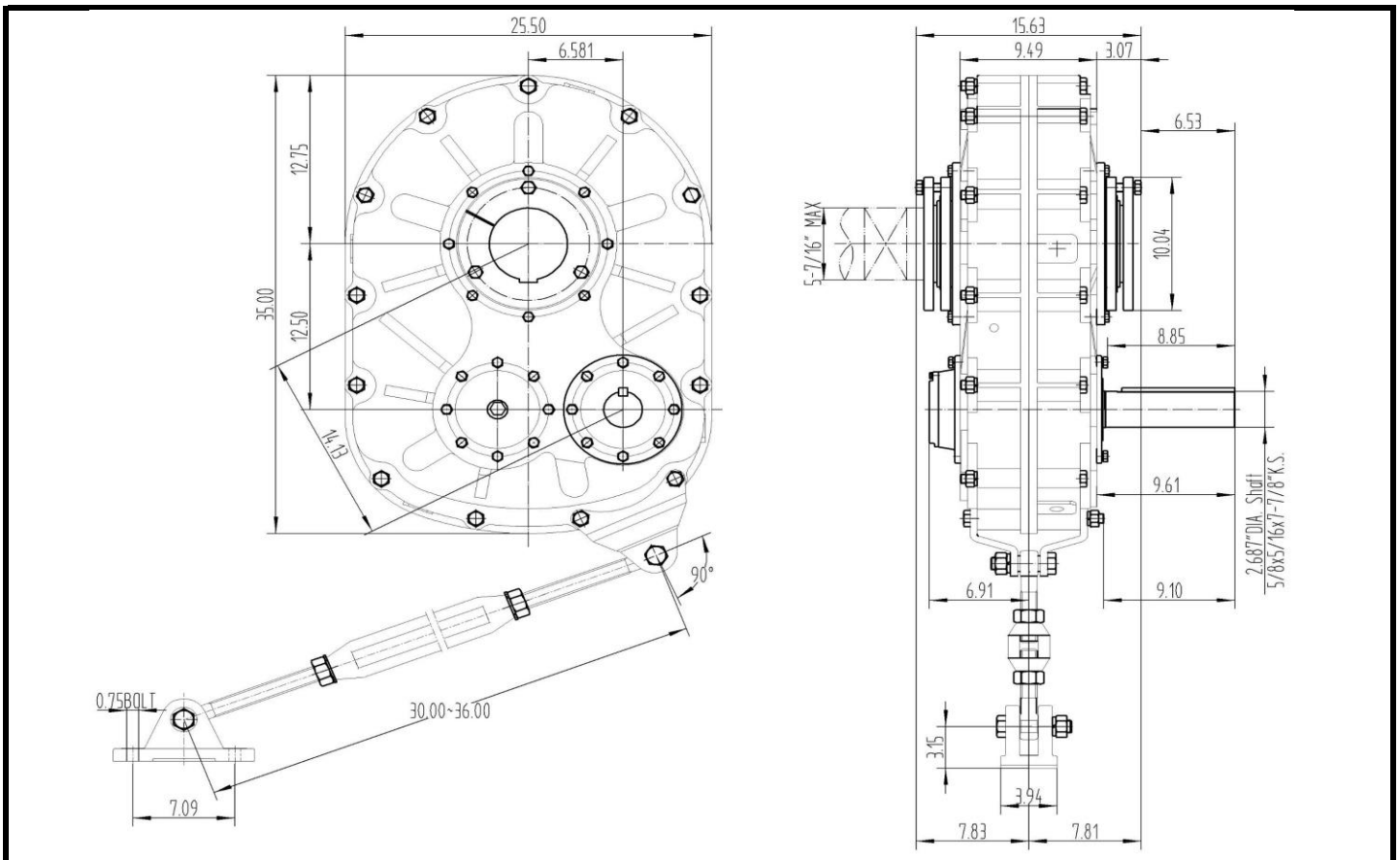

REVISED 07/14/14