

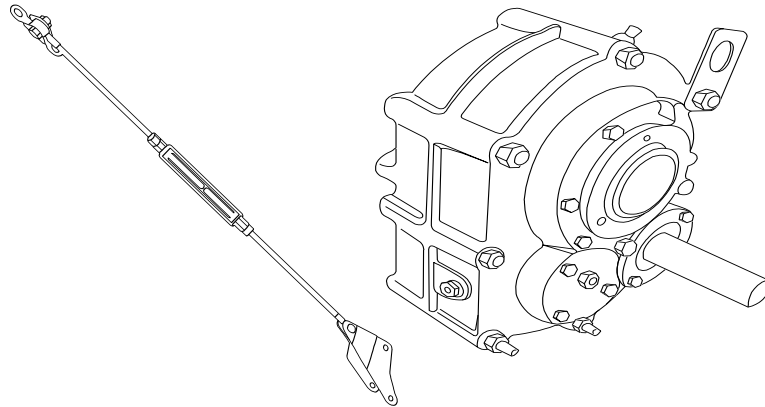

SHAFT MOUNT SPEED REDUCER MODEL # SMR12-15/1



SPECIFICATIONS - Exact Dimensional Drop-In For All Major Makes

Box Size	Ratio	Output Bore
12	15:1	6-1/2" Max.

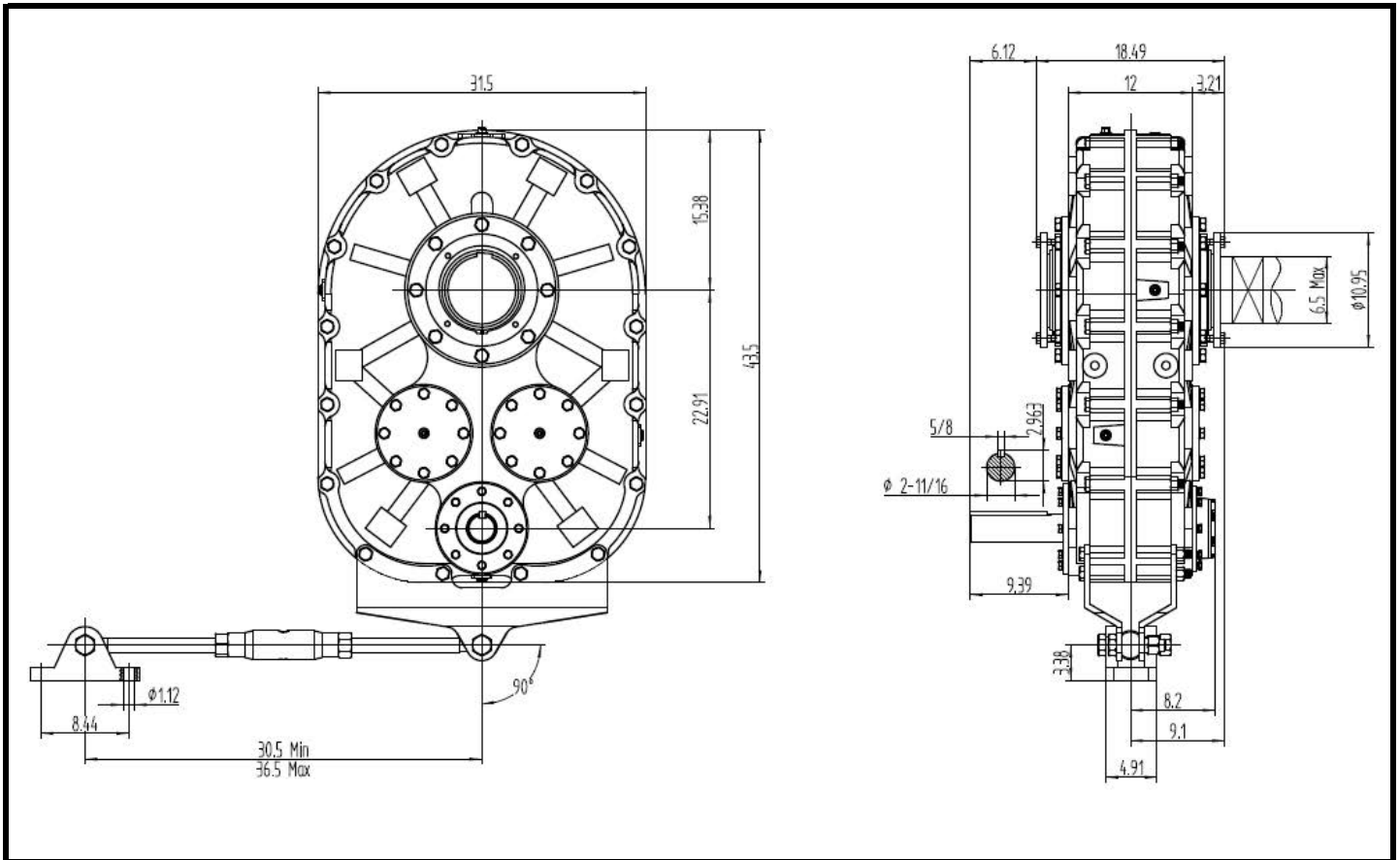

REVISED 03/06/2020