

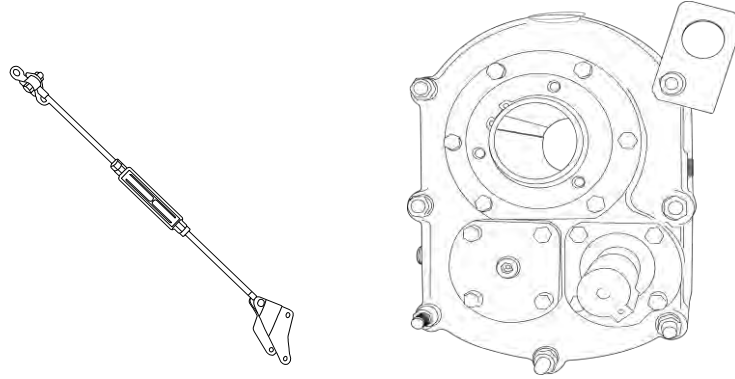

SHAFT MOUNT SPEED REDUCER MODEL # SMR2-25/1



SPECIFICATIONS - Exact Dimensional Drop-In For All Major Makes

Box Size	Ratio	Output Bore
2	25:1	1-15/16" Max.

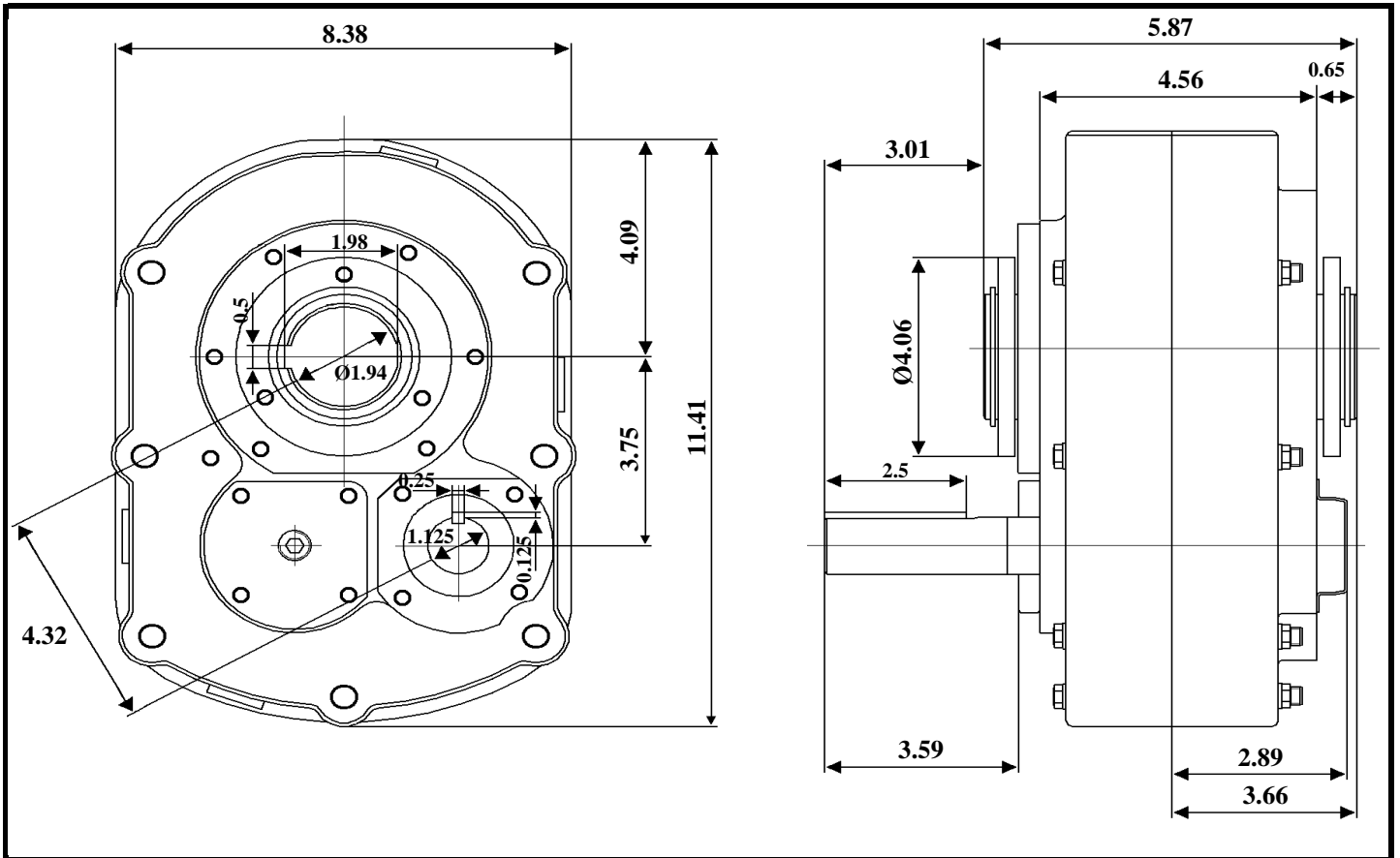

REVISED 08/18/17