

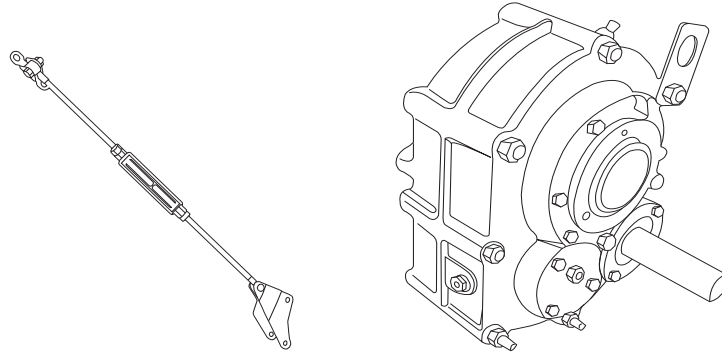

SHAFT MOUNT SPEED REDUCER MODEL # SMR3-15/1



SPECIFICATIONS - Exact Dimensional Drop-In For All Major Makes

Box Size	Ratio	Output Bore
3	15:1	2-3/16" Max.

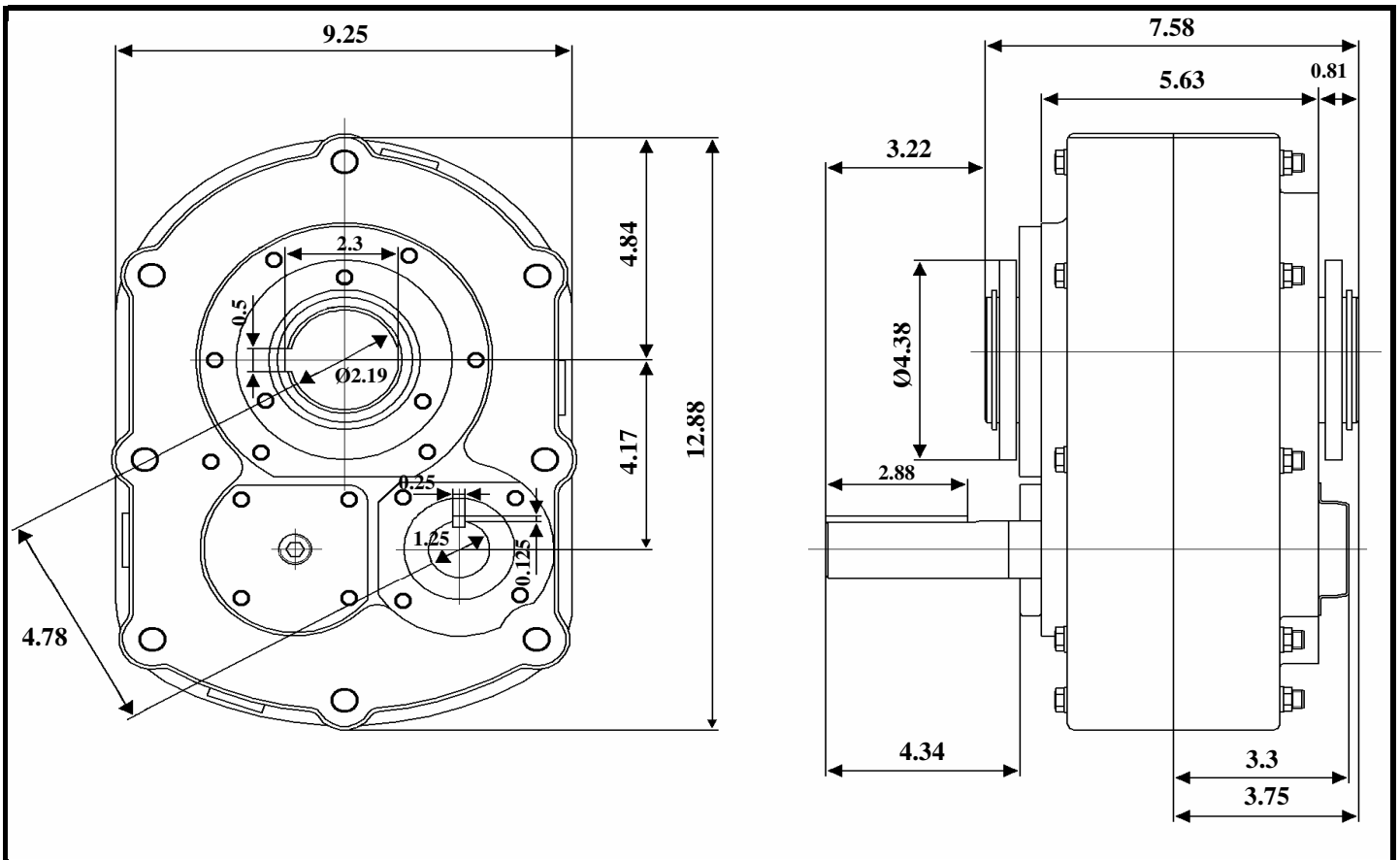

REVISED 08/18/08