

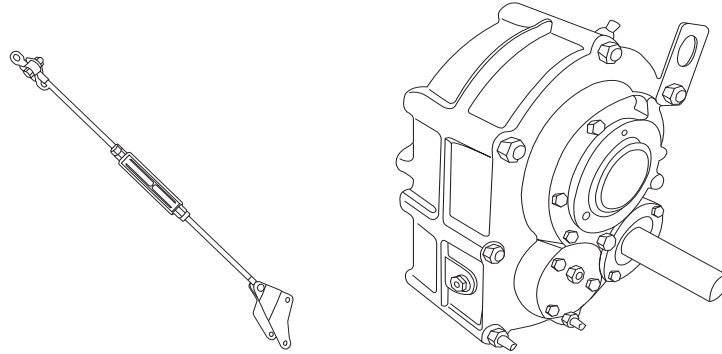

SHAFT MOUNT SPEED REDUCER MODEL # SMR4-25/1



SPECIFICATIONS - Exact Dimensional Drop-In For All Major Makes

Box Size	Ratio	Output Bore
4	25:1	2-7/16" Max.

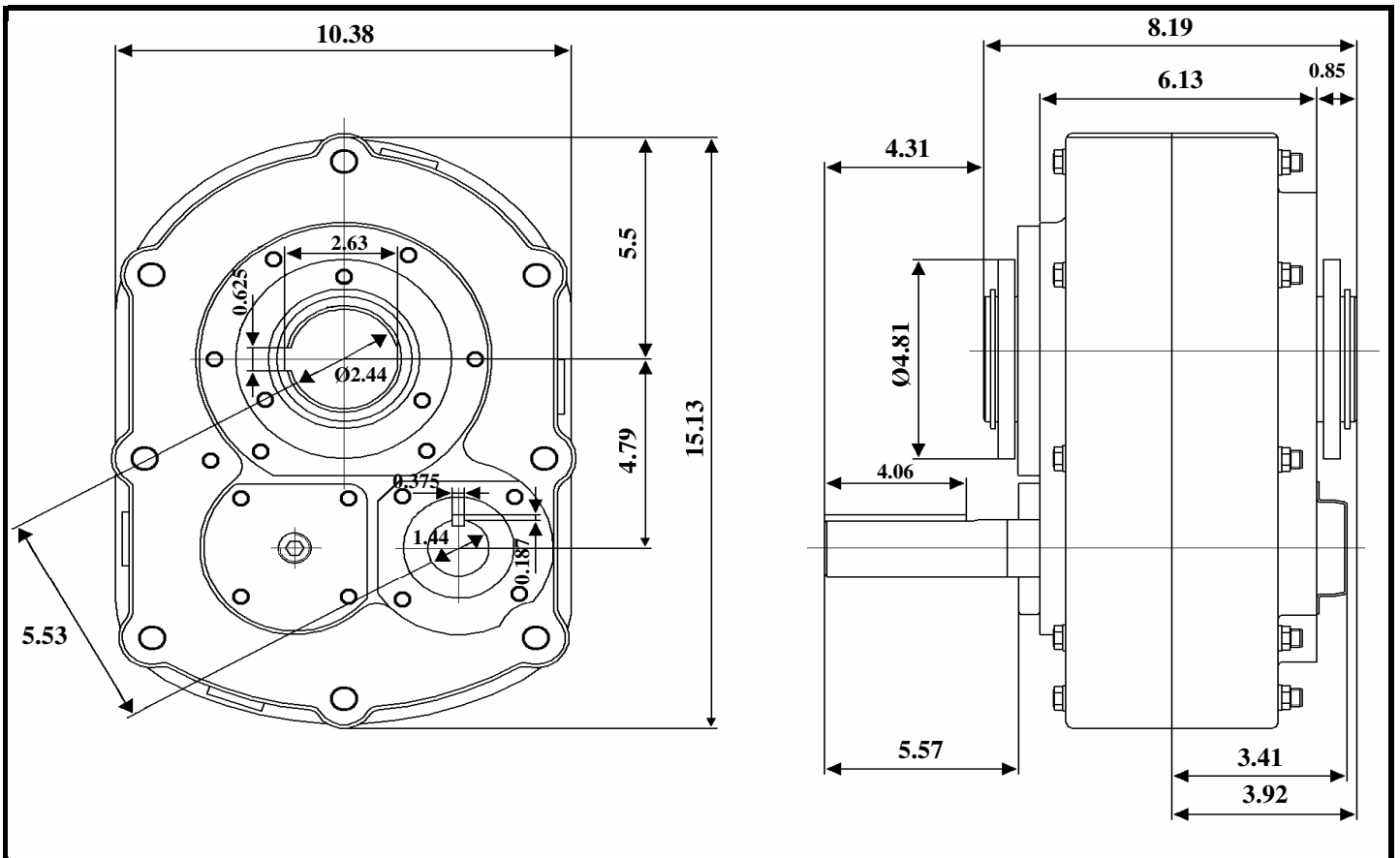

REVISED 08/18/08