

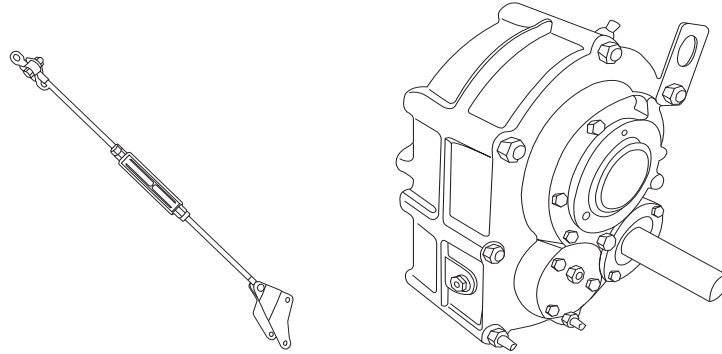

SHAFT MOUNT SPEED REDUCER MODEL # SMR6-25/1



SPECIFICATIONS - Exact Dimensional Drop-In For All Major Makes

Box Size	Ratio	Output Bore
6	25:1	3-7/16" Max.

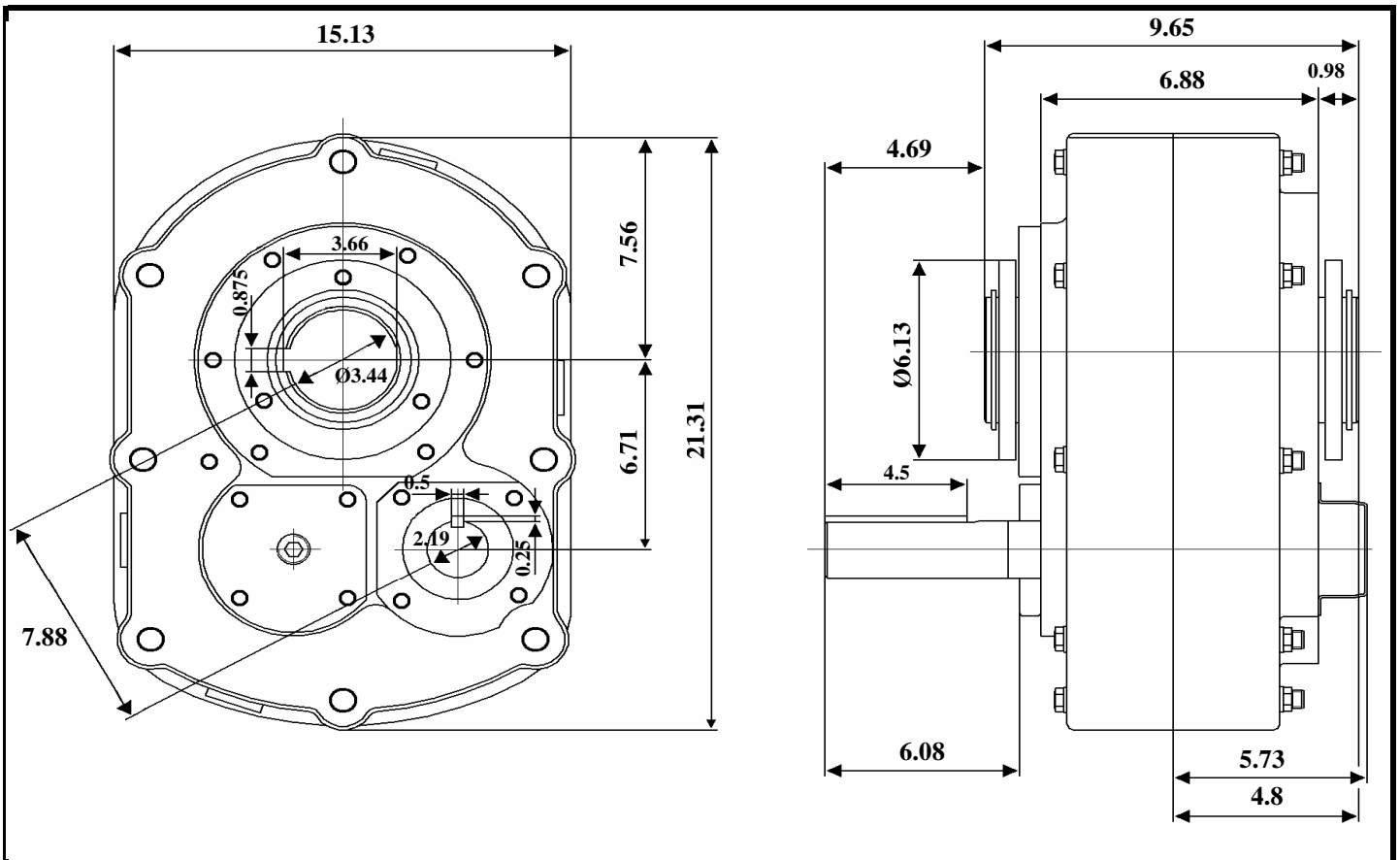

REVISED 08/18/08