

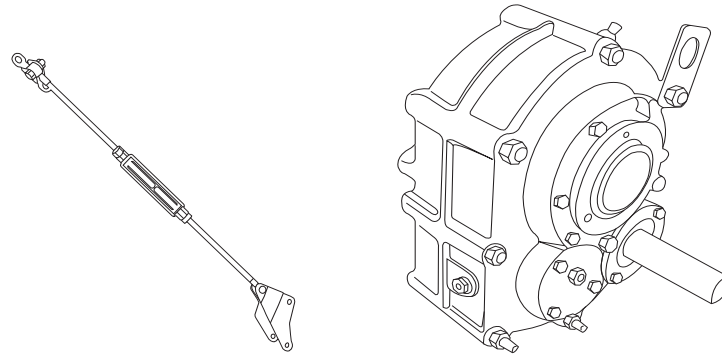

SHAFT MOUNT SPEED REDUCER MODEL # SMR8-25/1



SPECIFICATIONS - Exact Dimensional Drop-In For All Major Makes

Box Size	Ratio	Output Bore
8	25:1	4-7/16" Max.

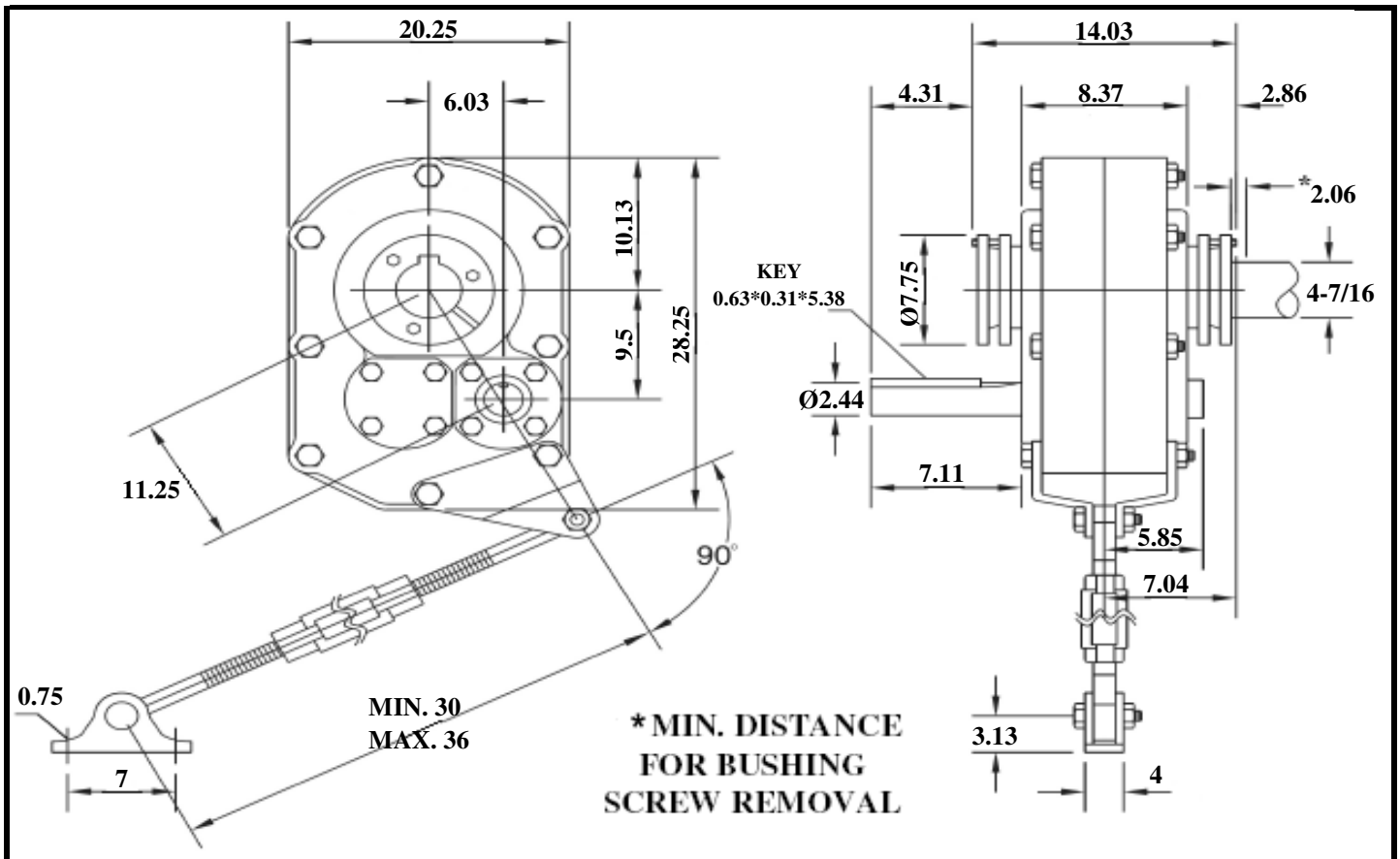

REVISED 08/18/08