

BOLT HOLE DETAILS

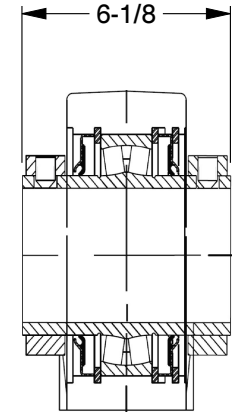
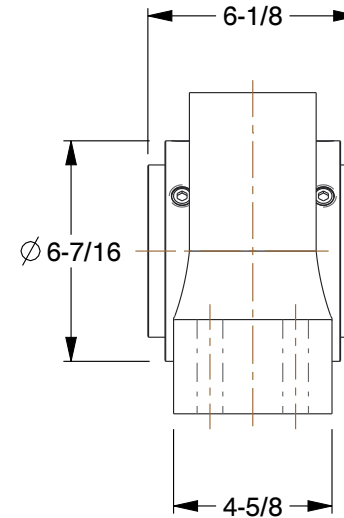
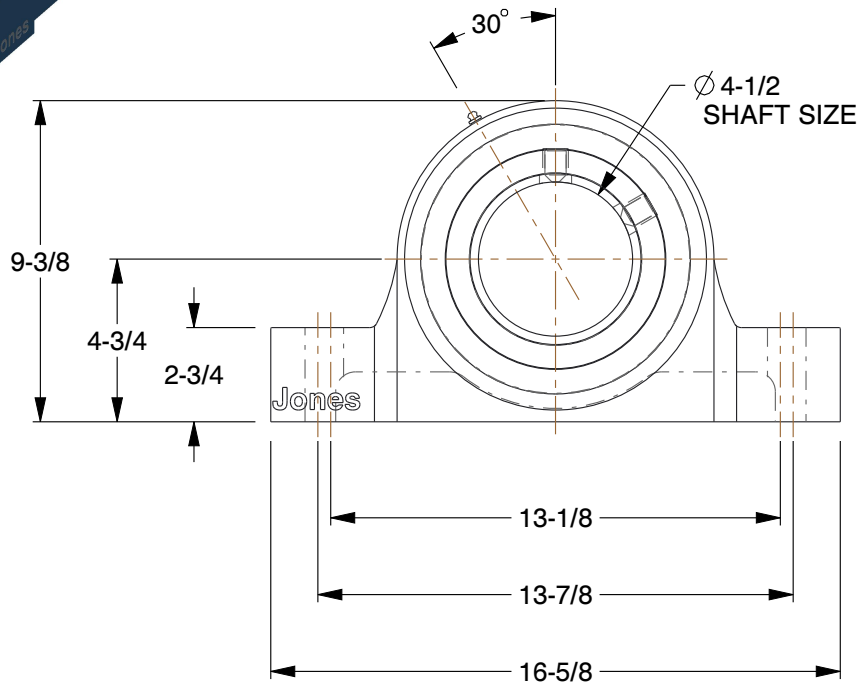

NON-EXPANSION(NXP)

NOTES:

1. FULLY SELF-ALIGNING
2. FIXED AND EXPANSION UNITS
3. APPROX. WEIGHT : 75 LBS
4. ALL DRAWING DIMENSIONS ARE IN INCH.
5. DIMENSIONS ARE FOR REFERENCE ONLY, SUBJECT TO CHANGE WITHOUT NOTICE.



Jones Bearing Company
 1062A, Hwy 72 East,
 Pelham, AL 35124, USA
 Phone: (205) 663-3002
 Fax: (205) 664-3351
 Email: sales@jonesbearing.com

This drawing is the property of Jones Bearing Company. It contains confidential, proprietary information that is Jones Bearing Company property. Do not disclose to or duplicate for others except as authorized by Jones Bearing Company.

Tolerances (Inch)
 .xx = ± .01
 .xxx = ± .005
 x° = ± 1°
 or As Noted

SCALE 0.18

COMPONENT		PILLOW BLOCKS	
JE5408F PILLOW BLOCKS (4-BOLT) JE-2000		DATE	
		05/10/19	
		SHEET	
		1 of 1	