

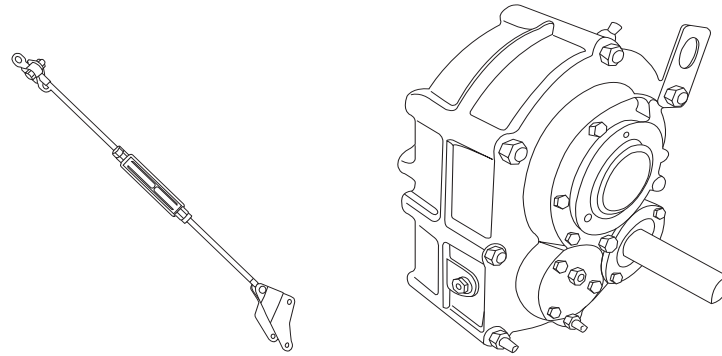

SHAFT MOUNT SPEED REDUCER MODEL # SMR7-15/1



SPECIFICATIONS - Exact Dimensional Drop-In For All Major Makes

Box Size	Ratio	Output Bore
7	15:1	3-15/16" Max.

