

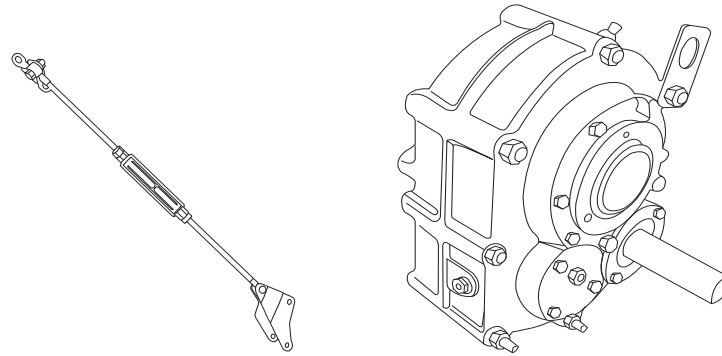

SHAFT MOUNT SPEED REDUCER MODEL # SMR7-25/1



SPECIFICATIONS - Exact Dimensional Drop-In For All Major Makes

Box Size	Ratio	Output Bore
7	25:1	3-15/16" Max.

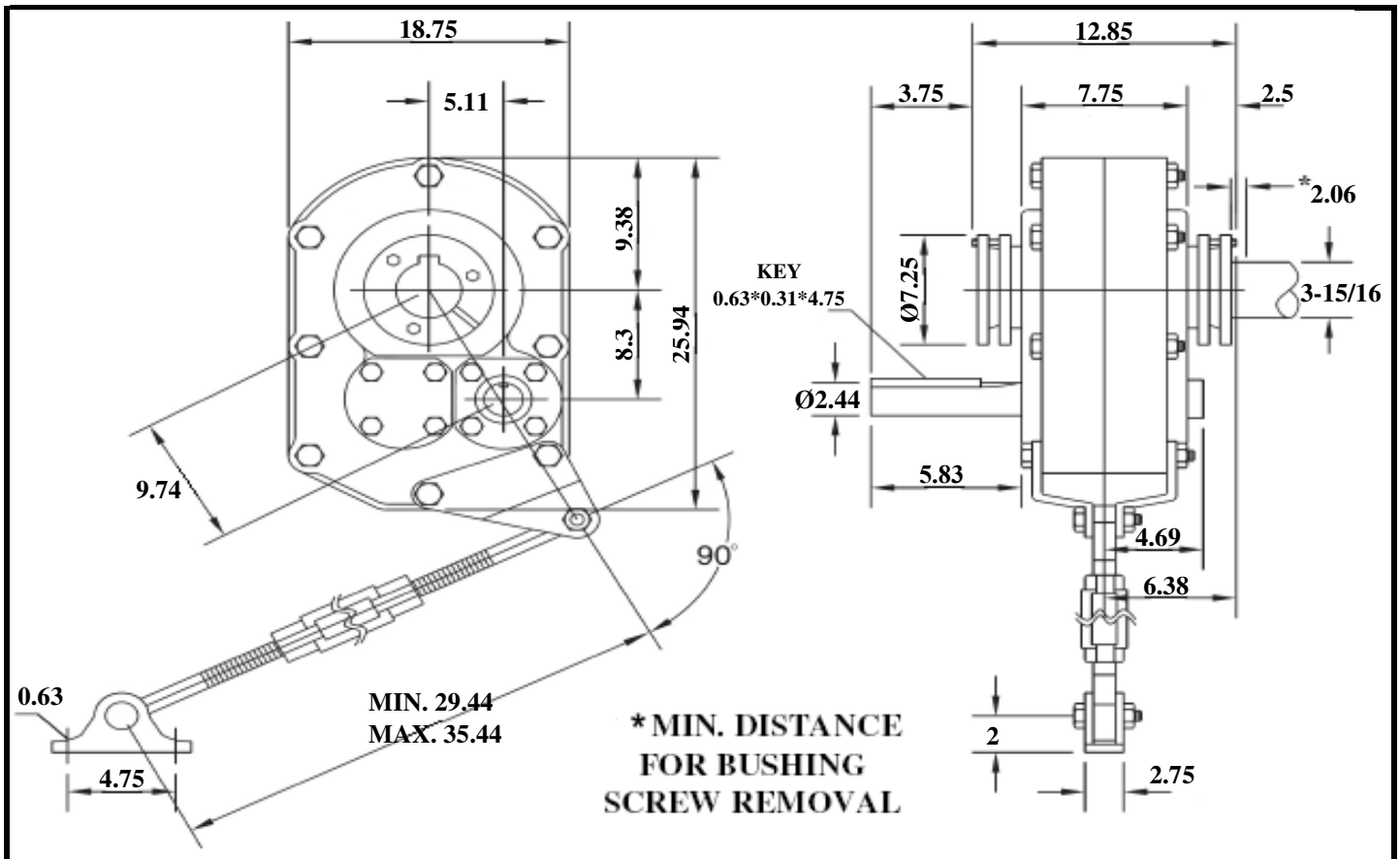

REVISED 07/22/18